

# Package Gas/Electric

## 4PGE15E



**10 year limited parts  
warranty / lifetime heat exchanger  
warranty available. See limited  
warranty document for details.**



GAS-FIRED



### REFRIGERANT SYSTEM

- Heavy-duty, high efficiency scroll compressor
- Copper tubing with enhanced fin coils

### HEAT EXCHANGER

- Aluminized steel tubular

### CABINET

- Insulation to minimize heat loss
- Powder paint for maximum durability
- Easy service access
- Louvered grille to protect condenser coil
- One piece "no leak" top design
- Weather protected heavy-duty condenser fan motor
- Aluminum fan for long life
- Internal filter rack

### BLOWER

- Insulated compartment to reduce sound
- Easy service split-ring design with quick plug-in wiring
- ECM variable speed motor for low maintenance and maximum efficiency
- Dynamically balanced blower wheel with resilient motor mounts for smooth and quiet operation

### CONTROLS

- Trade available components
- Comfort Alter™ diagnostic continually monitors system operation for easy service
- Solid state integrated blower control/ignition control board with L.E.D. diagnostics
- Color coded wiring for easy service

### INSTALLATION

- Horizontal or down discharge
- All models comply with California Low NOx regulations
- Rectangular duct covers

### ACCESSORIES

- Hinged Roofcurb
- Lifting Brackets
- Internal Filter Kits
- Low Ambient Kit
- LP Gas Conversion

# AIREASE

Built for life. Yours.™

# Model Number Guide

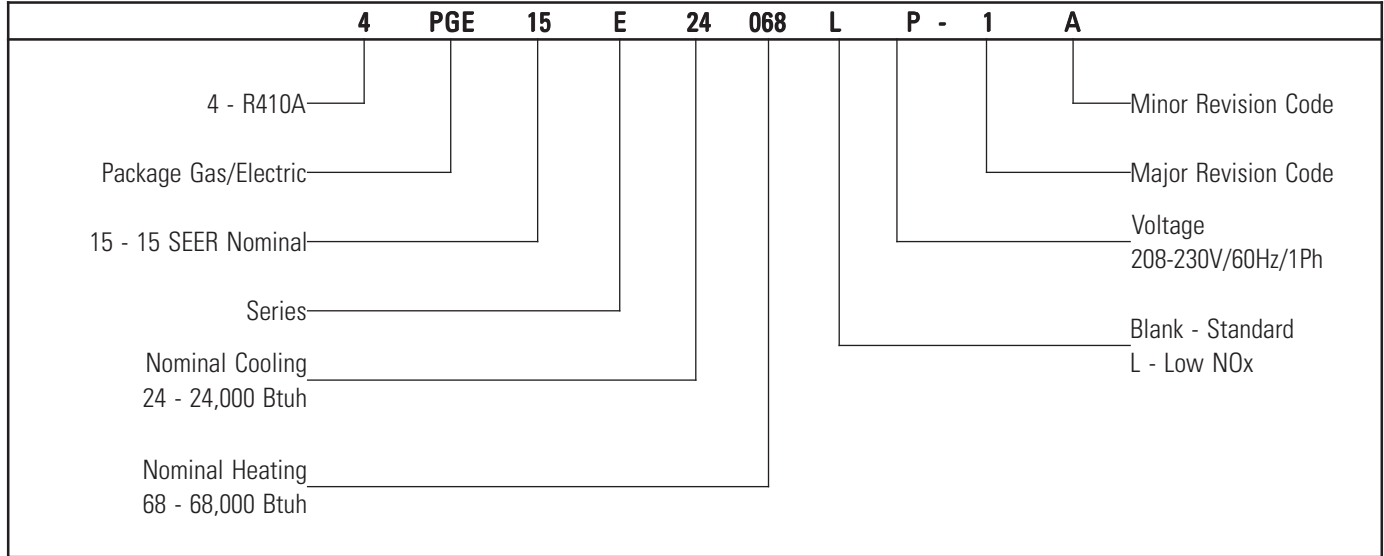

## Physical and Electrical

Model	Voltage/Hz/ Phase	Voltage Range	Min. Circ Amp.	Max. Over current Device (amps)	Compressor		Fan Motor			Indoor Blower		Exhaust Motor		Weight (lbs.)
					Rated Load (amps)	Locked Rotor (amps)	Rated Load (amps)	Rated HP	Nom. RPM	Rated Load (amps)	Rated HP	Rated Load (amps)	Rated HP	
4PGE15E24068P	208-230/60/1	197-253	20	25	13.4	58.3	1.1	.17	1075	1.5	1/3	1.06	1/30	390
4PGE15E30068P	208-230/60/1	197-253	21	25	14.1	73	1.1	.17	1075	1.5	1/3	1.06	1/30	390
4PGE15E36(068,090)P	208-230/60/1	197-253	21	25	14.1	77	1.1	.17	1075	1.5	1/2	1.06	1/30	415
4PGE15E42(083,110)P	208-230/60/1	197-253	27	35	17.7	107	1.7	1/4	825	2.7	3/4	1.06	1/30	560
4PGE15E48(083,110,138)P	208-230/60/1	197-253	32	40	21.8	117	1.7	1/4	825	2.7	3/4	1.06	1/30	570
4PGE15E60(083,110,138)P	208-230/60/1	197-253	38	50	26.4	134	1.7	1/4	825	2.7	3/4	1.06	1/30	595

## Performance

Model	SEER	EER	Rated ARI Capacity <sup>1</sup>	Rated Sensible Capacity	CFM	Input Btuh	Output Btuh	AFUE	Temp. Rise °F
4PGE15E24068P	14.50	12.40	23,000	17,900	800	67,500	54,000	80%	35-65
4PGE15E30068P	14.00	12.40	28,200	21,400	1000	67,500	54,000	80%	35-65
4PGE15E36068P	15.00	12.40	35,000	27,300	1200	67,500	54,000	80%	35-65
4PGE15E36090P	15.00	12.40	35,000	27,300	1200	90,000	72,000	80%	35-65
4PGE15E42083P	14.50	12.40	41,500	30,300	1400	82,500	66,000	80%	30-60
4PGE15E42110P	14.50	12.40	41,500	30,300	1400	110,000	88,000	80%	45-75
4PGE15E48083P	14.00	11.80	47,500	35,600	1600	82,500	66,000	80%	30-60
4PGE15E48110P	14.00	11.80	47,500	35,600	1600	110,000	72,000	80%	45-75
4PGE15E48138P	14.00	11.80	47,500	35,600	1600	137,500	110,000	80%	45-75
4PGE15E60083P	14.00	11.70	59,000	43,000	1800	82,500	66,000	80%	30-60
4PGE15E60110P	14.00	11.70	59,000	43,000	1800	110,000	88,000	80%	45-75
4PGE15E60138P	14.00	11.70	59,000	43,000	1800	137,500	110,000	80%	45-75

<sup>1</sup>Certified in accordance with Unitary Air Conditioner Certification Program, which is based on ARI Standard 210/240.

## Blower Performance

Model	Adjust Jumper Setting	Jumper Speed Positions											
		Cool Speed				Heat Speed				Continuous Fan Speed			
		A (cfm)	B (cfm)	C (cfm)	D (cfm)	A (cfm)	B (cfm)	C (cfm)	D (cfm)	A (cfm)	B (cfm)	C (cfm)	D (cfm)
4PGE15E24	+	1,150	920	690	1,035	1,265	1,150	1,035	920	575	460	345	520
	Norm	1,000	800	600	900	1,100	1,000	900	800	500	400	300	450
	-	850	680	510	765	935	850	765	680	425	340	300	385
4PGE15E30	+	1,150	920	690	1,035	1,265	1,150	1,035	920	575	460	345	520
	Norm	1,000	800	600	900	1,100	1,000	900	800	500	400	300	450
	-	850	680	510	765	935	850	765	680	425	340	300	385
4PGE15E36	+	1,380	1,150	920	1,265	1,555	1,265	1,150	1,035	690	575	460	635
	Norm	1,200	1,000	800	100	1,350	1,100	1,000	900	600	500	400	550
	-	1,020	850	680	935	1,150	935	850	765	510	425	350	470
4PGE15E42	+	2,070	1,840	1,610	1,380	2,015	1,900	1,555	1,325	1,035	920	805	690
	Norm	1,800	1,600	1,400	1,200	1,750	1,650	1,350	1,150	900	800	700	600
	-	1,530	1,360	1,190	1,020	1,490	1,405	1,150	980	765	680	595	510
4PGE15E48	+	2,070	1,840	1,610	1,380	2,015	1,900	1,555	1,325	1,035	920	805	690
	Norm	1,800	1,600	1,400	1,200	1,750	1,650	1,350	1,150	900	800	700	600
	-	1,530	1,360	1,190	1,020	1,490	1,405	1,150	980	765	680	595	510
4PGE15E60	+	2,070	1,840	1,610	1,380	2,015	1,900	1,555	1,325	1,035	920	805	690
	Norm	1,800	1,600	1,400	1,200	1,750	1,650	1,350	1,150	900	800	700	600
	-	1,530	1,360	1,190	1,020	1,490	1,405	1,150	980	765	680	595	510

## Cooling Performance Extended Ratings

Outdoor Model	Indoor Temp DB/WB °F	Outdoor Temp - DB°F														
		65			82			95			105			115		
		Btuh	S/T	kW	Btuh	S/T	kW	Btuh	S/T	kW	Btuh	S/T	kW	Btuh	S/T	kW
4PGE15E24068P	85/72	27,100	.66	1.59	25,100	.68	1.68	24,400	.75	1.86	23,000	.78	2.06	21,500	.80	2.29
	80/67	25,300	.73	1.44	24,200	.73	1.64	23,000	.78	1.85	21,700	.81	2.05	20,300	.83	2.27
	75/63	24,200	.73	1.42	23,000	.73	1.61	21,900	.81	1.84	20,600	.84	2.03	19,300	.87	2.25
4PGE15E30068P	85/72	33,300	.64	2.00	30,800	.66	2.11	29,900	.73	2.34	28,200	.76	2.60	26,400	.78	2.90
	80/67	31,000	.71	1.81	29,700	.71	2.06	28,200	.76	2.32	26,600	.79	2.58	24,900	.81	2.88
	75/63	29,600	.71	1.78	28,200	.71	2.02	26,800	.79	2.30	25,300	.82	2.56	23,600	.84	2.85
4PGE15E36(068,090)P	85/72	41,300	.66	2.43	38,200	.68	2.57	37,100	.75	2.83	35,000	.77	3.15	32,700	.80	3.52
	80/67	38,500	.73	2.20	36,800	.73	2.50	35,000	.78	2.82	33,000	.80	3.14	30,900	.83	3.50
	75/63	36,800	.73	2.17	35,000	.73	2.45	33,300	.81	2.80	31,400	.83	3.11	29,300	.86	3.47
4PGE15E42(083,110)P	85/72	49,000	.62	2.89	45,300	.64	3.05	44,000	.70	3.37	41,500	.72	3.75	38,800	.75	4.17
	80/67	45,700	.68	2.61	43,700	.68	2.97	41,500	.73	3.35	39,200	.75	3.73	36,600	.78	4.15
	75/63	43,600	.69	2.58	41,500	.69	2.91	39,400	.76	3.32	37,200	.78	3.69	34,800	.81	4.12
4PGE15E48(083,110,138)P	85/72	56,100	.63	3.47	51,900	.65	3.67	50,400	.72	4.06	48,000	.74	4.52	45,200	.76	5.05
	80/67	52,300	.70	3.14	50,000	.70	3.57	47,500	.75	4.03	45,200	.77	4.49	42,700	.79	5.00
	75/63	49,900	.71	3.10	47,600	.71	3.51	45,100	.77	4.00	43,000	.79	4.45	40,500	.82	4.96
4PGE15E60(083,110,138)P	85/72	69,600	.62	4.34	64,400	.64	4.58	62,500	.70	5.08	59,600	.72	5.64	56,200	.74	6.28
	80/67	64,900	.68	3.93	62,100	.68	4.47	59,000	.73	5.04	56,200	.75	5.60	53,000	.77	6.23
	75/63	62,000	.69	3.88	59,100	.69	4.38	56,100	.75	5.00	53,400	.77	5.55	50,400	.79	6.17

# Accessories

Kit Number	Description	Used With
34M72	Low Ambient Kit	All 4PGE's
92M51	Lifting Brackets	All 4PGE's
92M54	Internal Filter Kit	4PGE 24, 30, 36
92M55	Internal Filter Kit	4PGE 42, 48, 60
92M57	LP Conversion Kit	4PGE 68 and 90
92M58	LP Conversion Kit	4PGE 83, 110, and 138
92M99	Roof Curb 8 inch height	4PGE 24, 30, 36
93M00	Roof Curb 14 inch height	4PGE 24, 30, 36
93M01	Roof Curb 8 inch height	4PGE 42, 48, 60
93M02	Roof Curb 14 inch height	4PGE 42, 48, 60

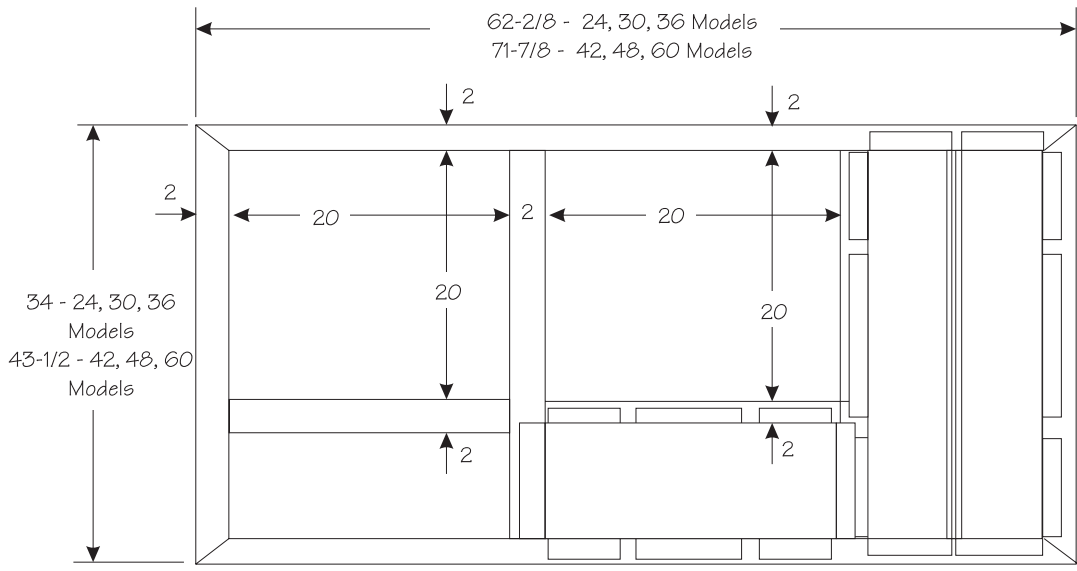

TOP VIEW

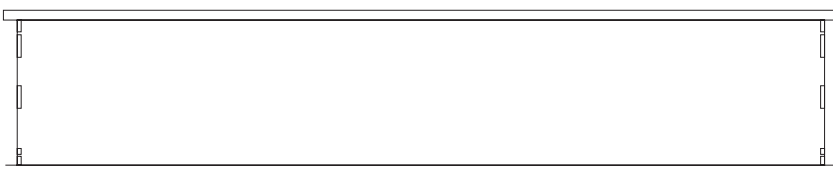

SIDE VIEW

# Dimensions (in.)

Model	A	B	C	D	E	F	G	H	J	K	L
4PGE15E24	34 1/4	65 3/8	36 1/2	11 1/4	17 1/4	20	8 1/2	3	20 1/4	4 1/2	19
4PGE15E30											
4PGE15E36											
4PGE15E42	38 1/4	75	46	11 1/4	19 1/4	22	9 1/4	3 1/4	22 1/4	4	16 1/4
4PGE15E48											
4PGE15E60											

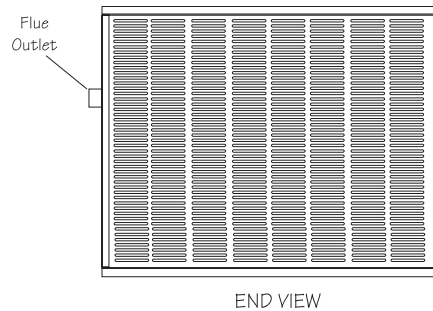
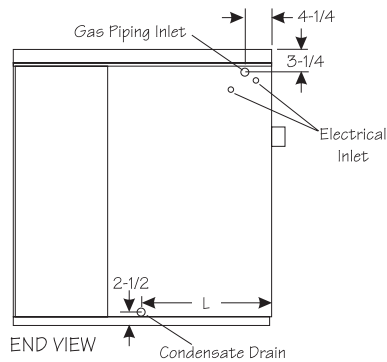
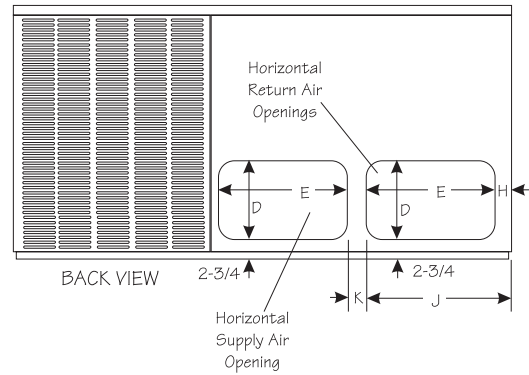
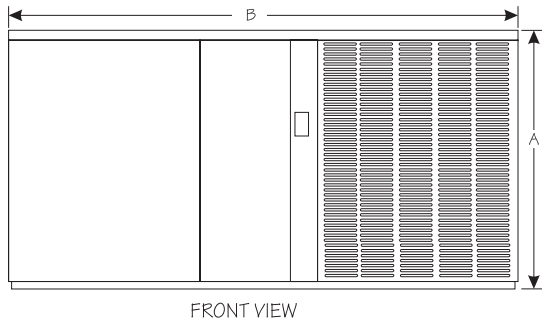
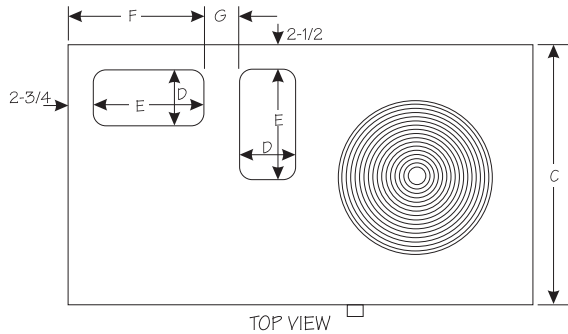

Built for life.Yours.<sup>SM</sup>

1-800-448-5872  
www.airease.com